

Features:

- polyethylene container with 150 litres capacity and up to 80 litres switching volume
- two built-up grinder pumps with robust, adjustable cutting system made of corrosion-resistant special alloy
- two mechanical seals with intermediate oil chamber
- pressure outlet flange DN 50 with flanged connecting bend and non-return ball valve 1 1/4" FPT
- inlets: 3 x lateral DN 100 and 1 x top DN 100/150
- additional connections 1 1/2" for manual diaphragm pump
- air vent DN 70 (Ø 75mm)
- operation temperature max. 55°C
- operating mode S3 - 25%
- protection grade IP 68 - fully submersible

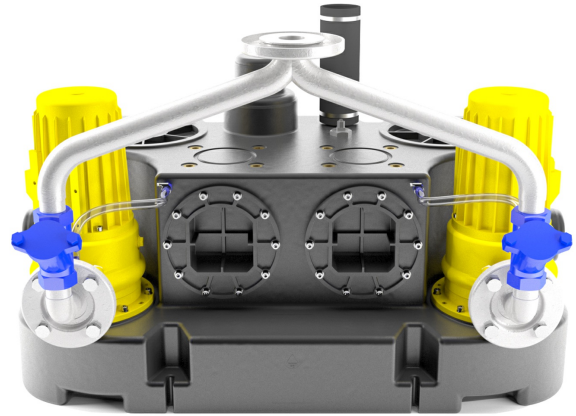

Application:

- pumping of domestic sewage from single-family houses and apartment buildings for greater heads or long pressure pipes
- above-ground installation in frost-free rooms below the backflow level

Scope of delivery:

- pre-assembled lifting unit with 3,5 m connection cable to the motor and 5,0 m pneumatic tube to the control
- 2 x 90° pump connecting bend DN 50
- 2 x non-return ball valve 1 1/4" FPT
- stainless steel Y-pipe DN 50/50/50 with pressure outlet flange DN 50
- flexible connection with tension clamps for ventilation pipe
- incl. ZPS2: comfortable, pneumatic level control with microcontroller, LCD plain text display for filling level, maintenance, operating hours, fault message and alarm signal in switchbox for indoor installation

Product benefits:

- compact dimensions
- pre-assembled - connection pieces & non-return valve included
- comfort control unit included in delivery
- for long pressure pipes (DN 50)
- suitable for pressure drainage
- high delivery heads

Technical data:

Art.no.	U [V]	P ₁ [W]	P ₂ [W]	I _n [A]	n [min ⁻¹]	Q _{max} [m ³ /h]	H _{max} [m]	P0	Weight [kg]
17752	400	2 x 3900	2 x 3200	2 x 6,5	2800	17,0	35,0	DN 50	144

Characteristics:

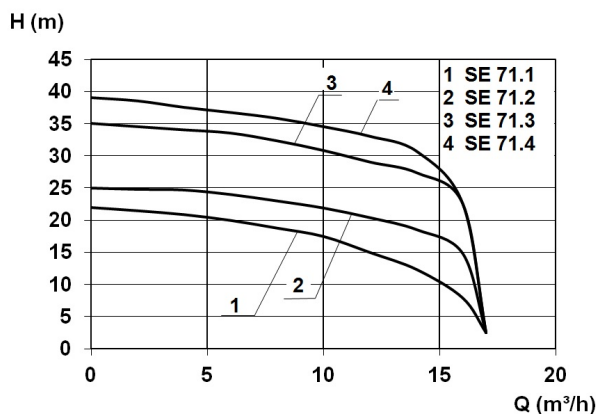

Materials:

Seal motor:	mechanical seal
Seal pump:	mechanical seal

Dimensions:

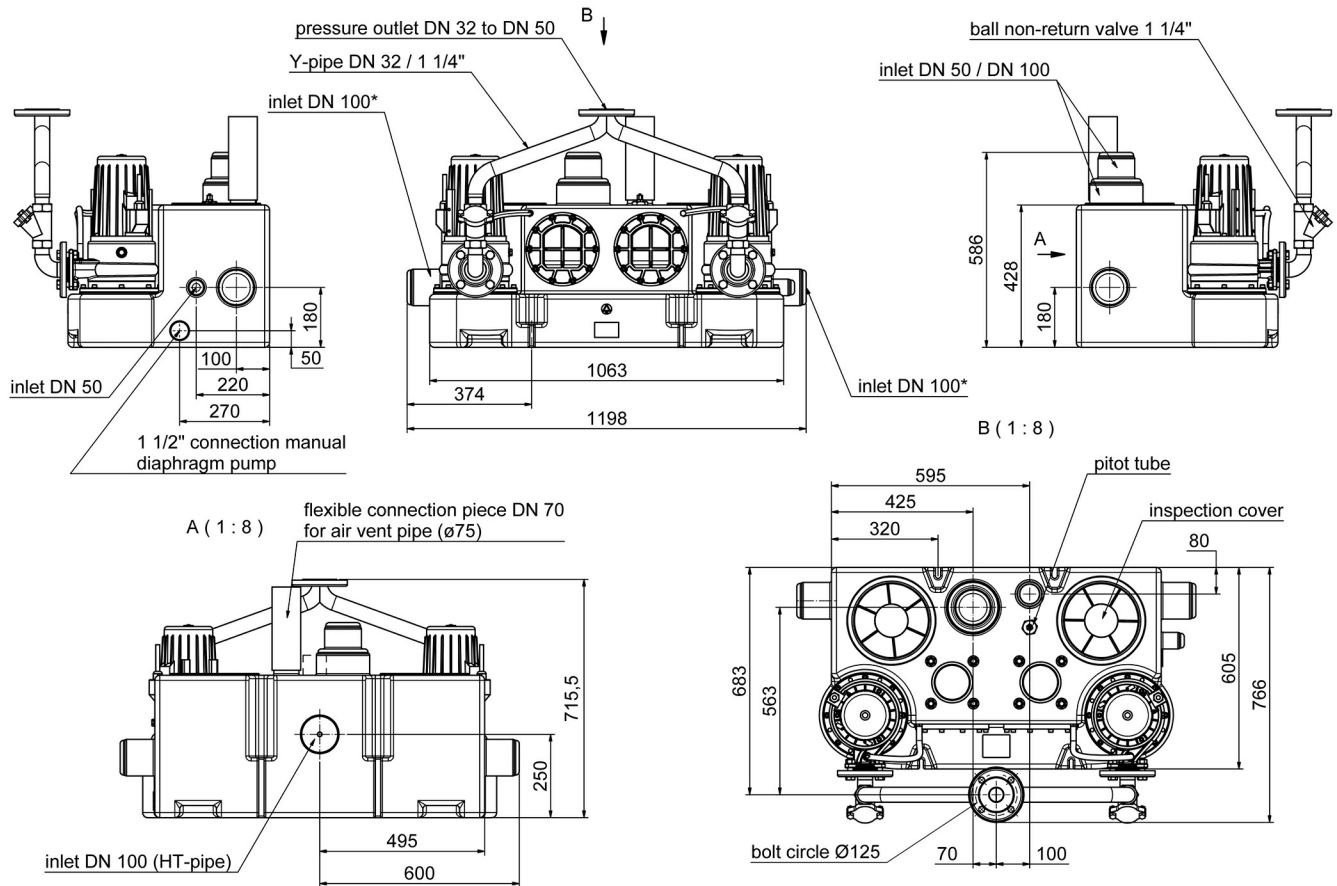

*this inlet must be directed to a height of 250 mm above the ground level directly after the lifting unit